

Pleszew
otwarty na ekologię

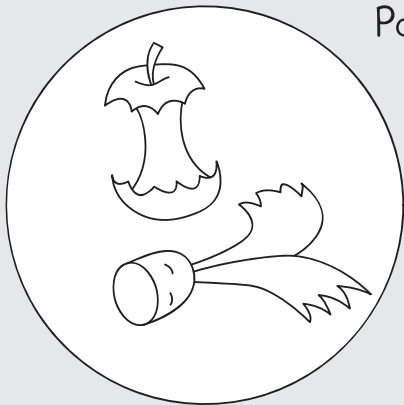

KOLOROWANKA
„Segreguję odpady”

Połącz zbiory odpadów z pomieszczeniami z których pochodzą.



W każdym domu powstają odpady.



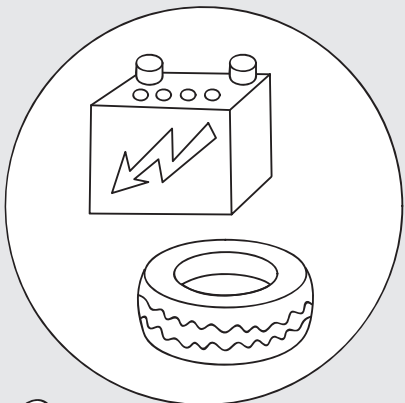
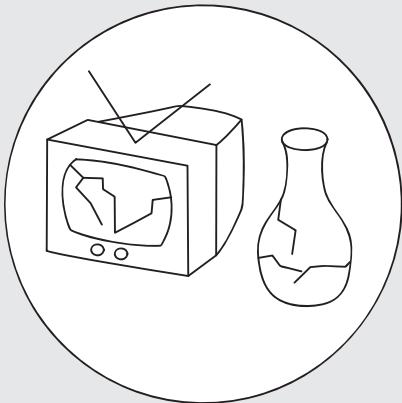

To bardzo
duzo śmieci!

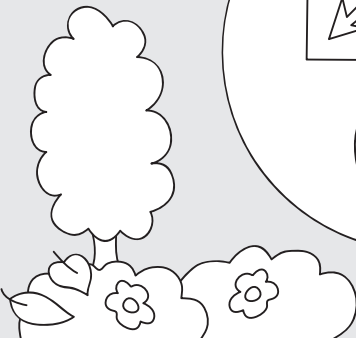

Niektóre odpady można
wykorzystać ponownie.

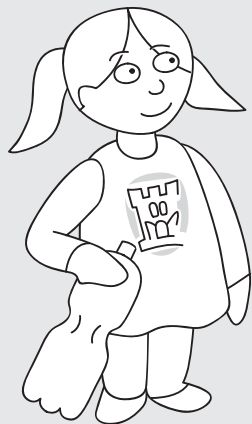

zielony worek



żółty worek

Wrzuć odpady do
odpowiedniego pojemnika.

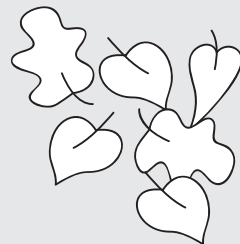
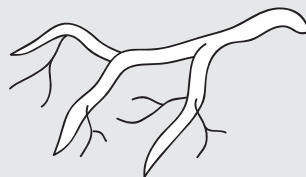
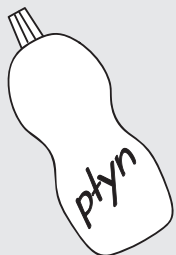
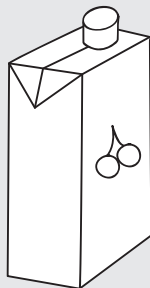
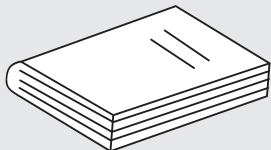
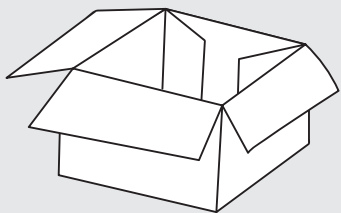

PAPIER

niebieski worek



POZOSTAŁE
ODPADY

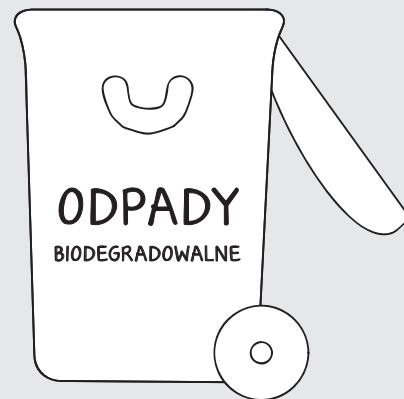

ODPADY
BIODEGRADOWALNE

Co się dzieje z odpadami,
które posegregujemy?

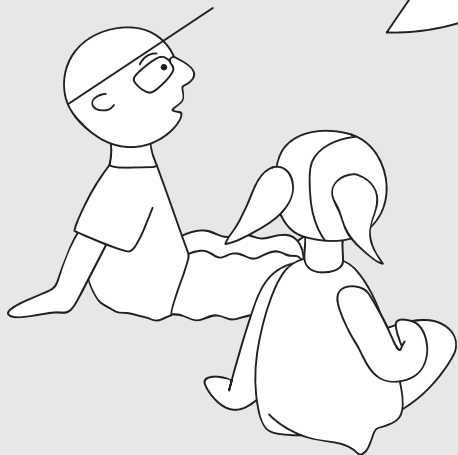

SZKŁO
worek zielony

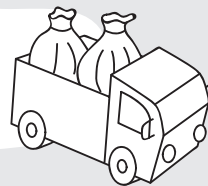

**ODPADY BIO-
DEGRADOWALNE**
brązowy

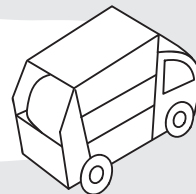

**POZOSTAŁE
ODPADY**
czarny



PLASTIK
worek żółty

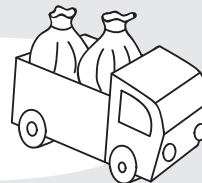

PAPIER
worek niebieski



Pokoloruj drogę
którą jadą samochody
odpowiednim kolorem.

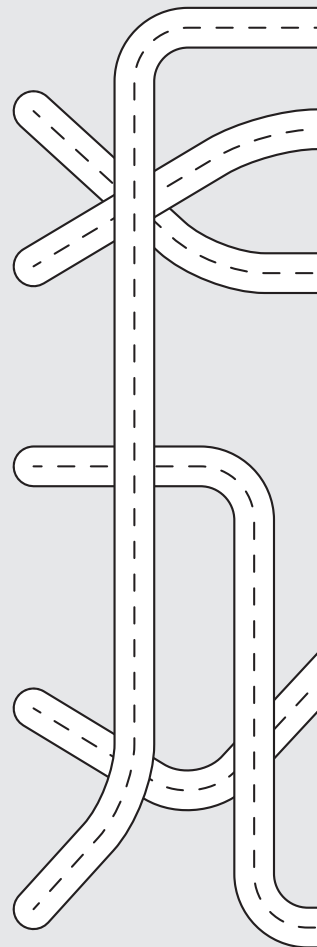

NOWE PRZEDMIOTY

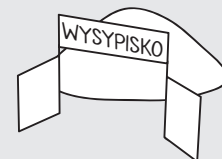
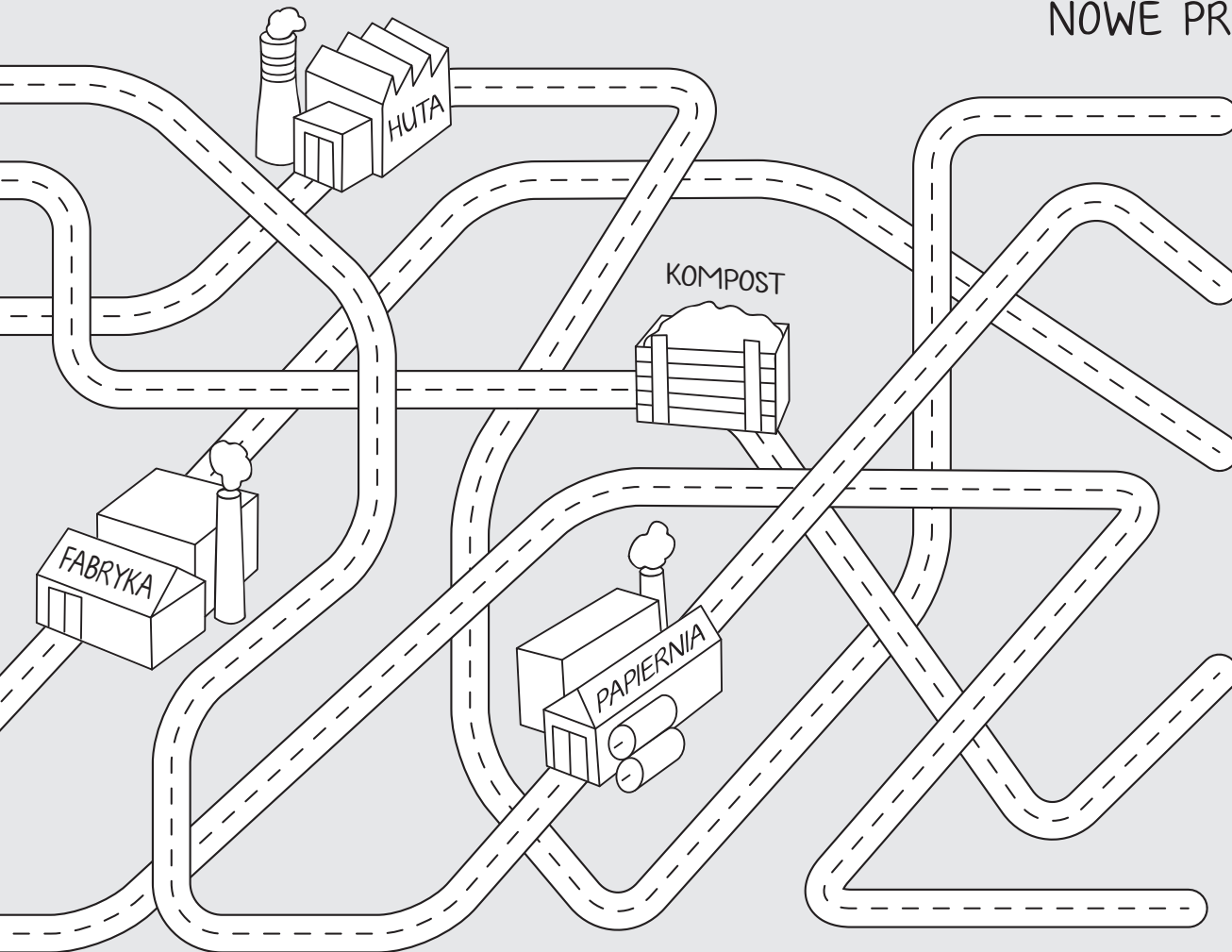

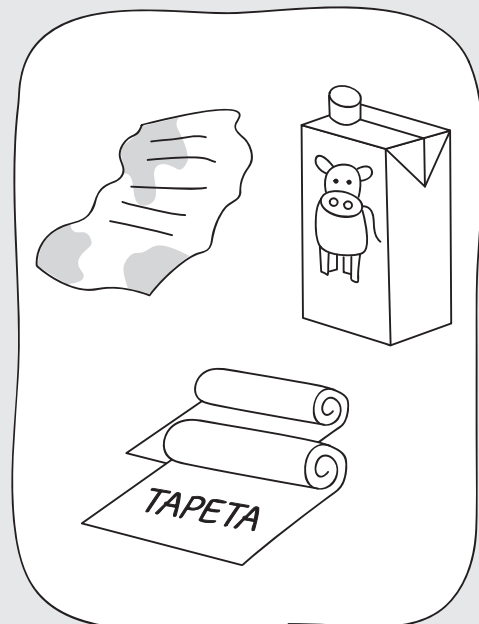
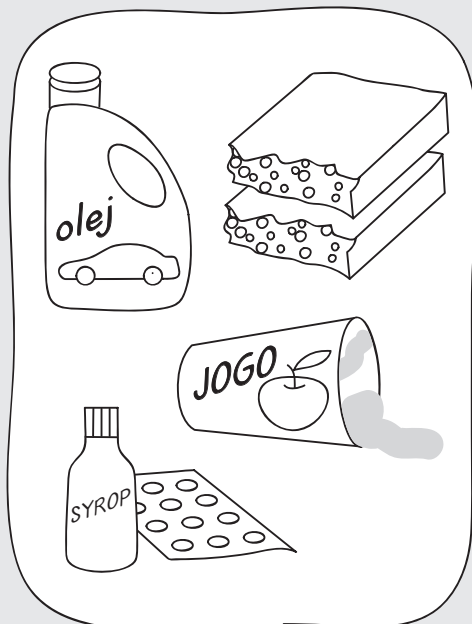
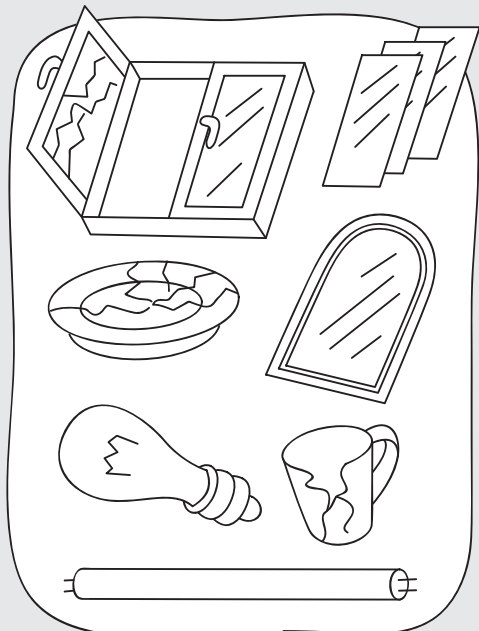

Tych przedmiotów NIE WOLNO wkładać do worków na odpady segregowane!

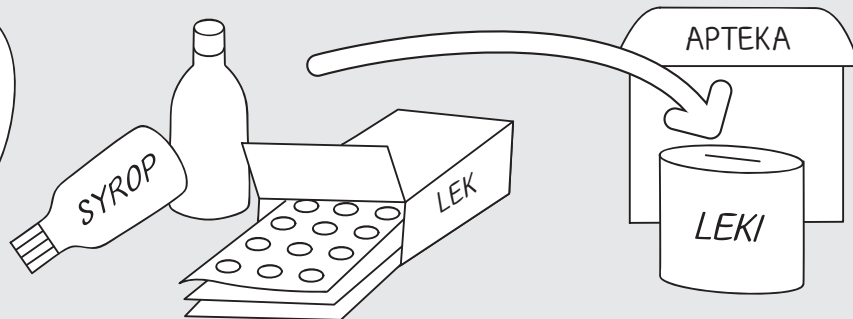

A te należy wrzucać do specjalnie oznaczonych pojemników.

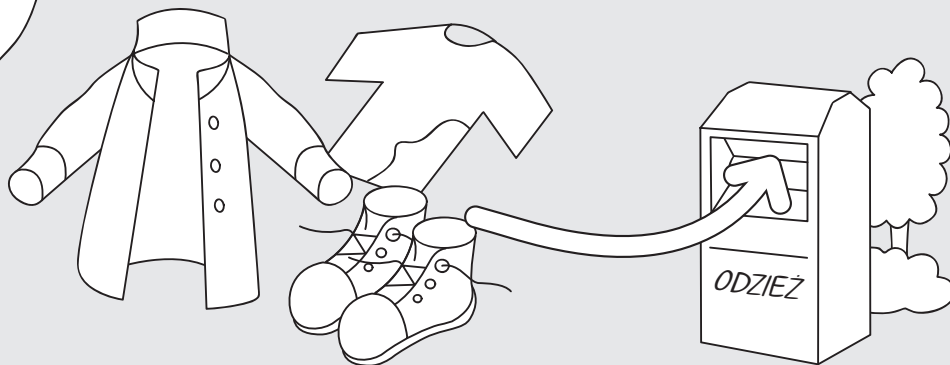
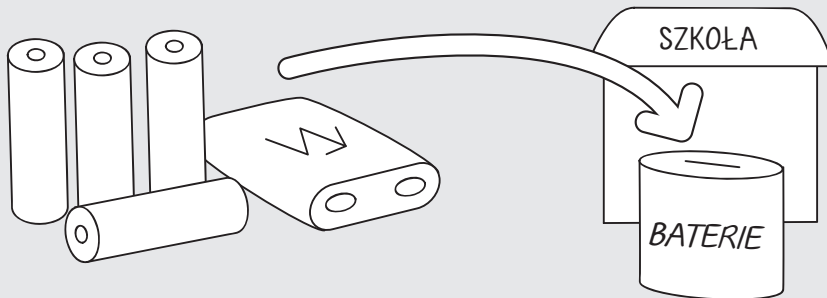
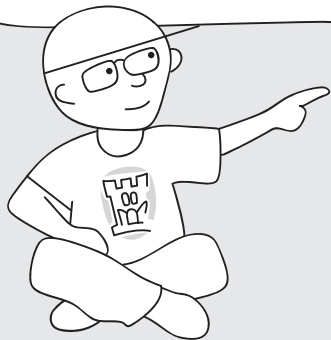

ODPADY NIEBEZPIECZNE i DUŻYCH ROZMIARÓW

Te przedmioty należy odwieźć
do specjalnego punktu selektywnego
zbierania odpadów. Pomóż znaleźć drogę!

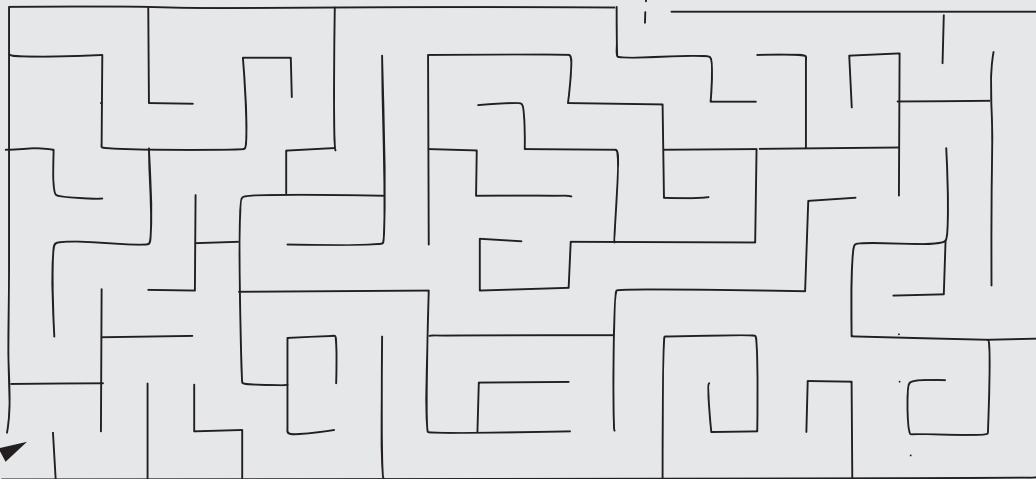
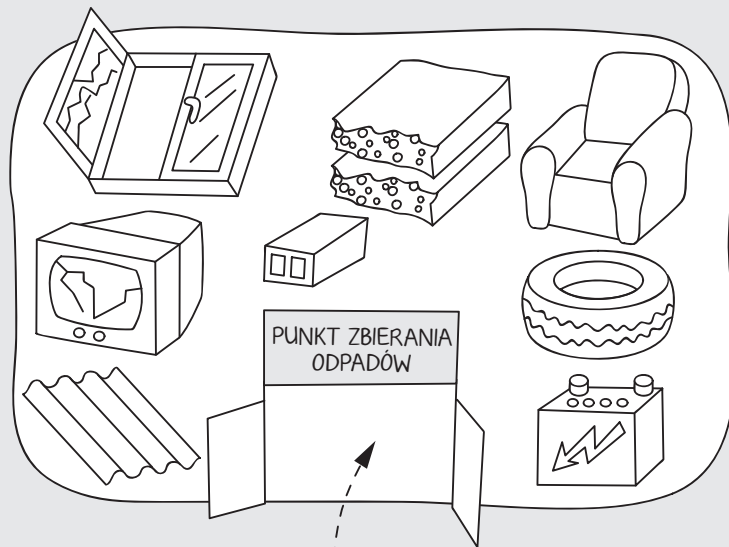
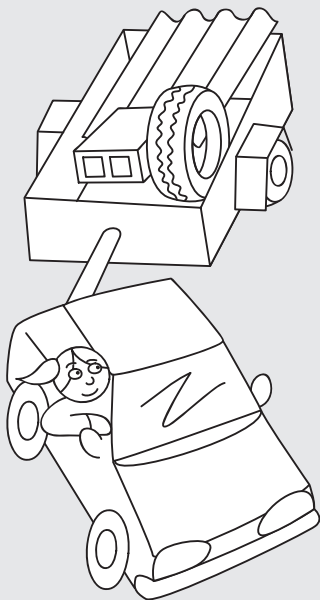

EKOLOGICZNY KUBECZEK Z PAPIERU

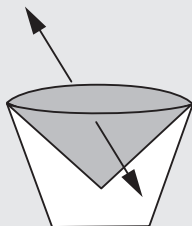
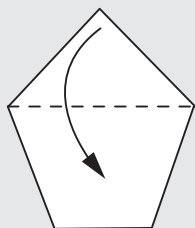
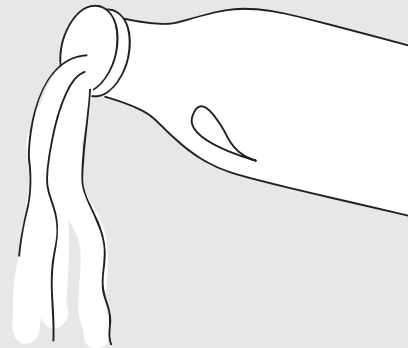
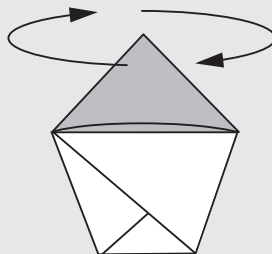
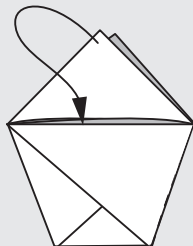
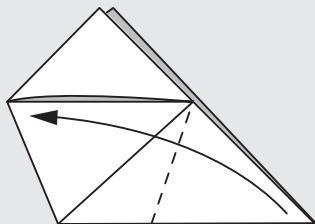
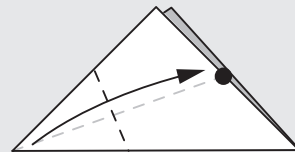
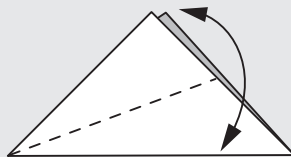
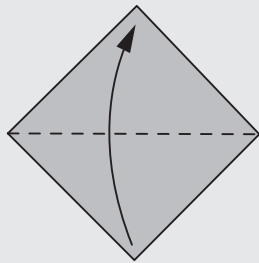
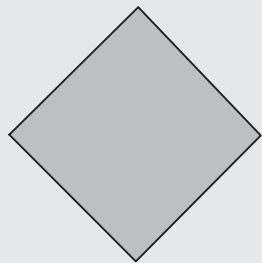

Można z niego pić!

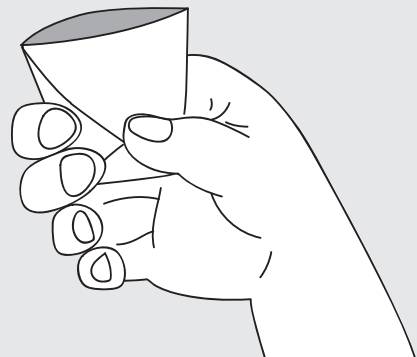

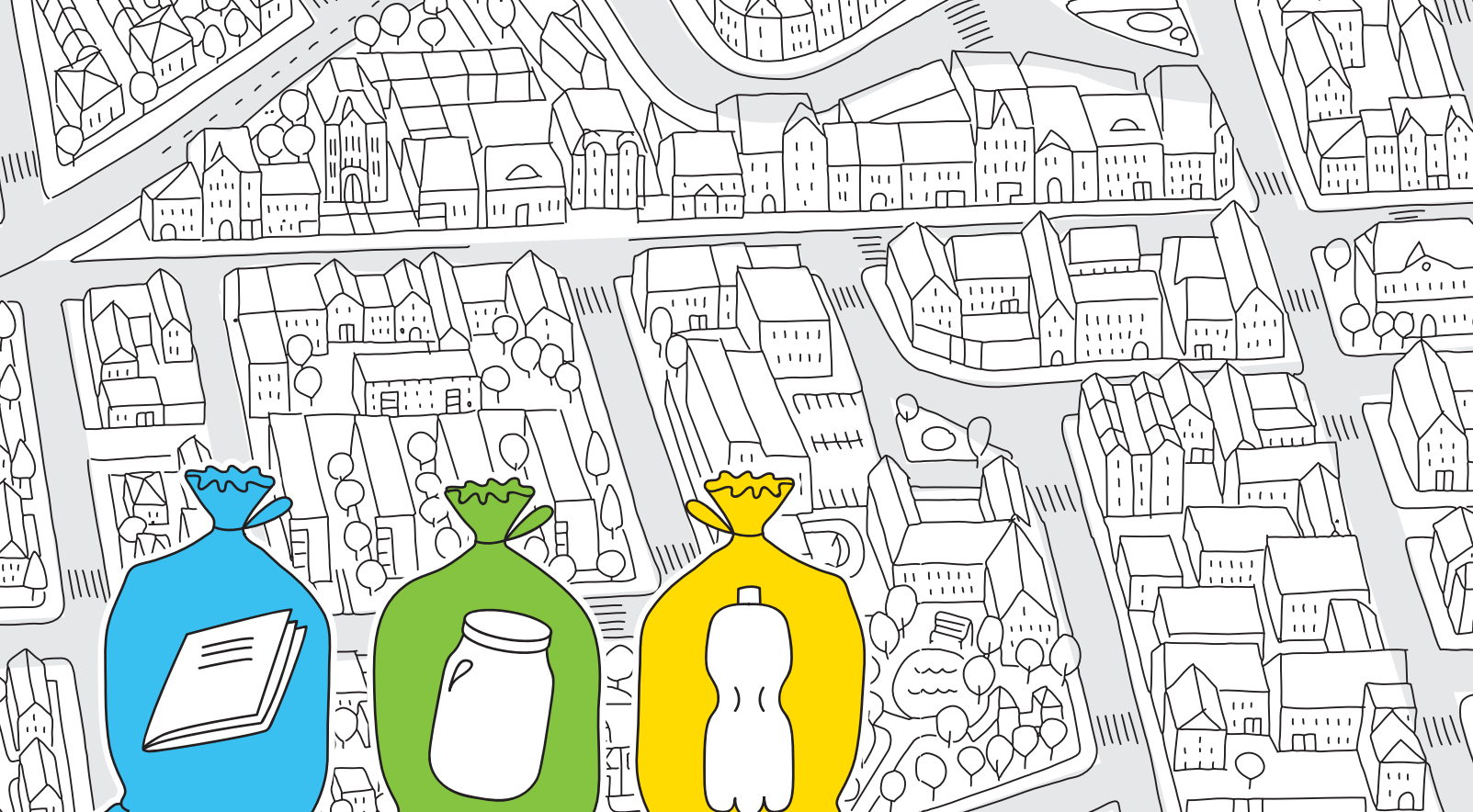

Projekt współfinansowany ze środków
Wojewódzkiego Funduszu Ochrony Środowiska
i Gospodarki Wodnej w Poznaniu



Pleszew
miasto otwarte

Miasto i Gmina Pleszew
63-300 Pleszew, Rynek 1
www.pleszew.pl